

Swing Check Valve Class 150 – ARTEK GROUP SRL

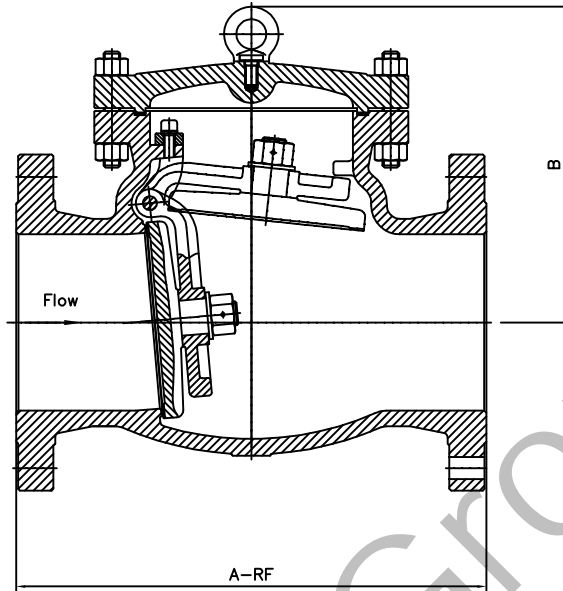

DESIGN AND MATERIALS ACC.TO NACE 0175/ISO 15156 LATEST EDITION
 FLANGED AND CONNECTIONS ACC.TO ANSI B16.5 / ANSI B16.25
 FACE TO FACE ACC.TO ANSI B16.10
 FLANGE FACING ACC.TO SMOOTH FINISH 125-250 AARH
 VALVE DESIGN API 600
 FULLY COMPLIANCE WITH PED 97/23/EC
 TEST AND INSPECTION API 598
 PRESSURE AND TEMP.RATING ANSI B16.34

Typical Bill for SWING CHECK

Component	TY1	TY2	TY3	Component	TY1	TY2	TY3
Body	ASTM A216WCB	ASTM A351CF8M	ASTM A351CF3M	Name Plate	Stainless Steel	Stainless Steel	Stainless Steel
Cover	ASTM A105	ASTM A182F304L	ASTM A182F316L	Cover Bolt	ASTM A193-B7	ASTM A193-B8	ASTM A193-B8M
Disc	ASTM A216WCB+STL.6	ASTM A351CF8M+STL.6	ASTM A351CF3M+STL.6	Cover Nuts	ASTM A194-2H	ASTM A194-GR.8	ASTM A194-GR.8M
Swing Arm	ASTM A216WCB	ASTM A351CF8M	ASTM A351CF3M	Disc Pin	ASTM A182F6	ASTM A182F304L	ASTM A182F316L
Seat Ring	ASTM A182F6+STL.6	ASTM A182F304L+STL.6	ASTM A182F316L+STL.6	Disc Nut	ASTM A194-2H	ASTM A194-GR.8	ASTM A194-GR.8M
Cover Gasket	SS316+Graphite	SS316+Graphite	SS316+Graphite				
Hinge Pin	ASTM A182F6	ASTM A182F304L	ASTM A182F316L				

Class 150

Size	nps	2	2.5	3	4	5	6	8	10	12	14	16	18	20	24
	dn	50	65	80	100	125	150	200	250	300	350	400	450	500	600
A-RF	in	7.0	7.5	8.0	9.0	10.0	10.5	11.5	13.0	14.0	15.0	16.0	17.0	18.0	20.0
	mm	178	191	203	229	254	267	292	330	356	381	406	432	457	508
A-BW	in	8.5	9.5	11.1	12.0	15.0	15.9	16.5	18.0	19.8	22.5	24.0	26.0	28.0	32.0
	mm	216	241	282	305	381	404	419	457	503	572	610	660	711	813
B	in	14.8	17.1	18.2	22.6	28.1	33.2	38.9	46.4	54.6	63.5	72.4	79.2	86.0	100.8
	mm	376	434	462	574	714	843	988	1179	1387	1613	1839	2012	2184	2560
RF	lbs	46	56	71	111	163	196	289	449	639	860	1190	1389	1786	2602
Wt.	kg	21	25	32	50	74	89	131	204	290	391	541	631	812	1183
BW	lbs	40	46	58	91	152	180	259	425	584	811	1146	1349	1720	2534
Wt.	kg	18	21	26	41	69	82	118	193	265	369	521	613	782	1152